

CPS Block 1 Phase 230 V

Power Line SPDs
NEMA - TVSS



General Data

Network configuration	1 Phase
IEC SPD Type	Class II
UL SPD Type	Type 2
Format	Monobloc
Protection Modes	Common & differential protection
Product standards	IEC 61643-11; UL 1449 4th edition



PART NUMBERS

XXX	120	160	200
CPS Block XXXkA 1 Ph 230V	77798612	77798632	77798652

SURGE PROTECTION DEVICE (SPD) - IEC TECHNICAL FEATURES

CPS Block XXXkA 1 Ph 230V	120	160	200
Nominal voltage AC 50-60 Hz - Un [V]		230	
Nominal voltage AC 50-60 Hz - Un(L-N) [V]		230	
Max Discharge Current (8/20) - I _{max}	120kA/ph	160kA/ph	200kA/ph
Maximum back-up fuse [A [gG]]		80	
Response time - t _A [ns]		≤1	

SURGE PROTECTION DEVICE (SPD) - UL TECHNICAL FEATURES

CPS Block XXXkA 1 Ph 230V	120	160	200
Nominal discharge current (8/20) - I _n [kA]		20	
Maximum continuous operating voltage - MCOV (L-N) [V]		320	
Voltage protection rating - VPR (L-N) [V]		1000	
Voltage protection rating - VPR (L-G) [V]		1000	
Voltage protection rating - VPR (N-G) [V]		1000	
Short-Circuit Current Rating-SCCR [kA]		200	

MECHANICAL AND ENVIRONMENTAL FEATURES

CPS Block XXXkA 1 Ph 230V	120	160	200
Temperature range [°C]		-40 ... 70	
Indication System Type		Protection status LED	
Enclosure - IP		IP55	
Stranded conductor cross section		2,5 mm ²	
Stranded conductor AWG dimensions		#14	

DATASHEET

This document is subject to change at any time without notice www.cirprotec.com | Lepanto 49 · 08223 Terrassa, Barcelona Spain © 2024 Cirprotec SLU | All rights reserved

cirprotec

CPS Block 1 Phase 230 V

DIMENSIONS AND WEIGHT

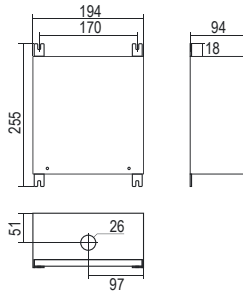

CPS Block XXX kA 1 Ph 230V	120	160	200
Net Weight [kg]	3.1		
Gross weight [kg]	3.25		
Packaging dimensions (H x W x L) [mm]	210 × 313 × 343		

INTERNAL CONFIGURATION

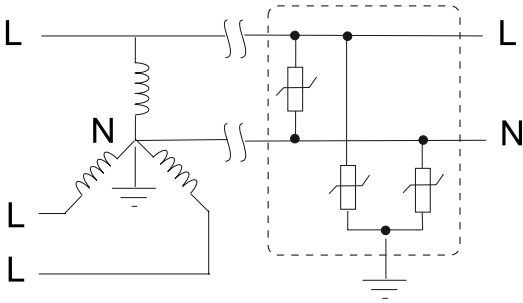

DATASHEET